

Computer Graphics

Texture Filtering

Philipp Slusallek

Filtering

- **Magnification (Zoom-in)**

- Map few texels onto many pixels
- Reconstruction filter:
 - Nearest neighbor interpolation:
 - Take the nearest texel
 - Bilinear interpolation:
 - Interpolation between 4 nearest texels
 - Need fractional accuracy of coordinates
 - Higher order interpolation

- **Minification (Zoom-out)**

- Map many texels to one pixel
 - Aliasing: Reconstructing high-frequency signals with low-frequency sampling
- Antialiasing (low-pass filtering)
 - Averaging over (many) texels associated with the given pixel
 - Computationally expensive

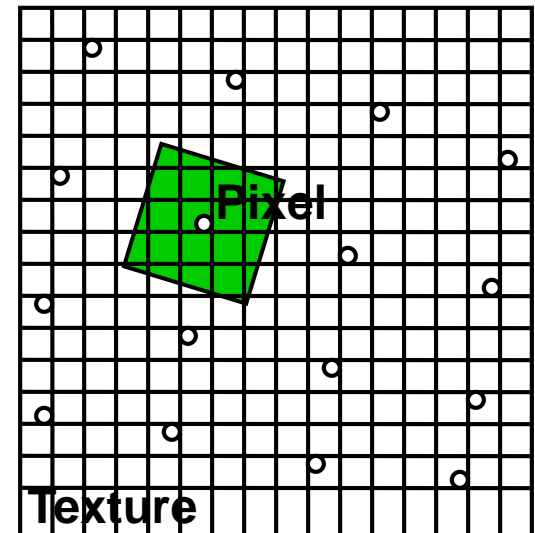
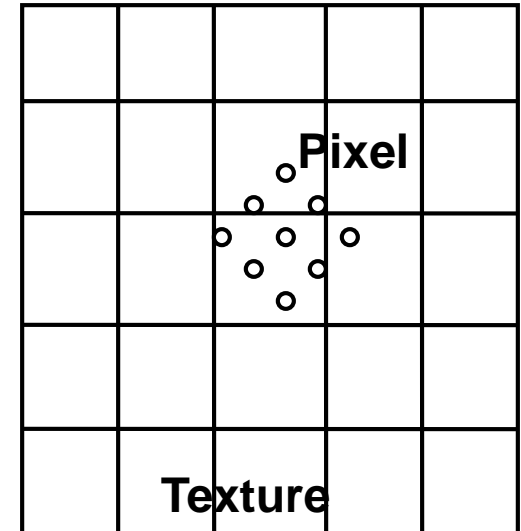

Aliasing Artifacts

- **Aliasing**

- Texture insufficiently sampled
- Incorrect pixel values
- “Randomly” changing pixels when moving

- **Integration of Pre-Image**

- Integration over pixel footprint in texture space

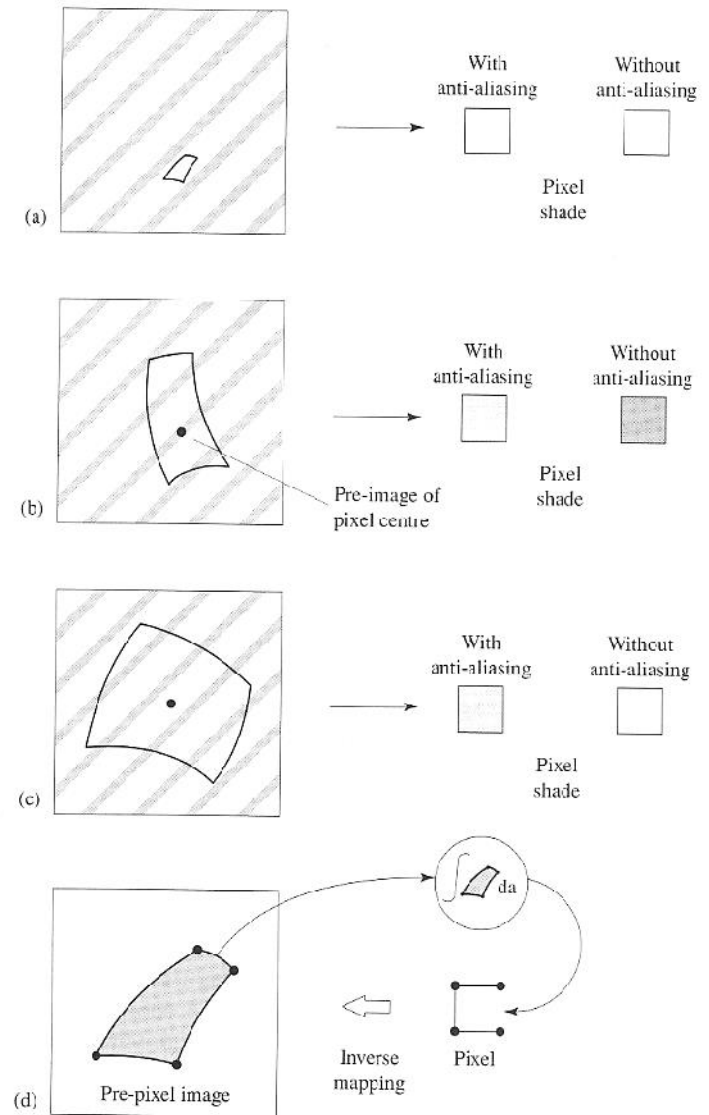
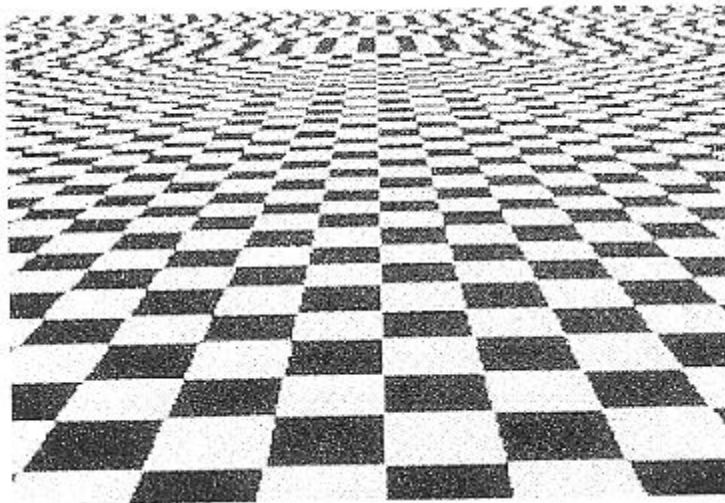

Sensors

- **Measurement of signal**

- Conversion of a continuous signal to discrete samples by integrating over the sensor field
 - Weighted with some sensor sensitivity function P

$$R(i,j) = \int_{A_{ij}} E(x,y) P_{ij}(x,y) dx dy$$

- Similar to physical processes
 - Different sensitivity of sensor to photons

- **Examples**

- Photo receptors in the retina
- CCD or CMOS cells in a digital camera

- **Virtual cameras in computer graphics**

- Analytic integration is expensive or even impossible
 - Needs to sample and integrate numerically
- Ray tracing: mathematically ideal point samples
 - Origin of aliasing artifacts !

The Digital Dilemma

- **Nature: continuous signal (2D/3D/4D)**

- Defined at every point



- **Acquisition: sampling**

- Rays, pixels/texels, spectral values, frames, ... (aliasing !)

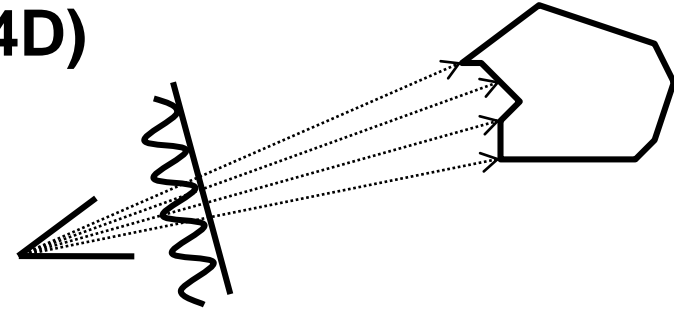

- **Representation: discrete data**

- Discrete points, discretized values



- **Reconstruction: filtering**

- Recreate continuous signal



- **Display and perception (!)**

- Hopefully similar to the original signal, no artifacts



Aliasing Example

- **Ray tracing**

- Textured plane with one ray for each pixel (say, at pixel center)
 - No texture filtering: equivalent to modeling with b/w tiles
- Checkerboard period becomes smaller than two pixels
 - At the Nyquist sampling limit
- Hits textured plane at only one point per pixel
 - Can be either black or white – essentially by “chance”
 - Can have correlations at certain locations

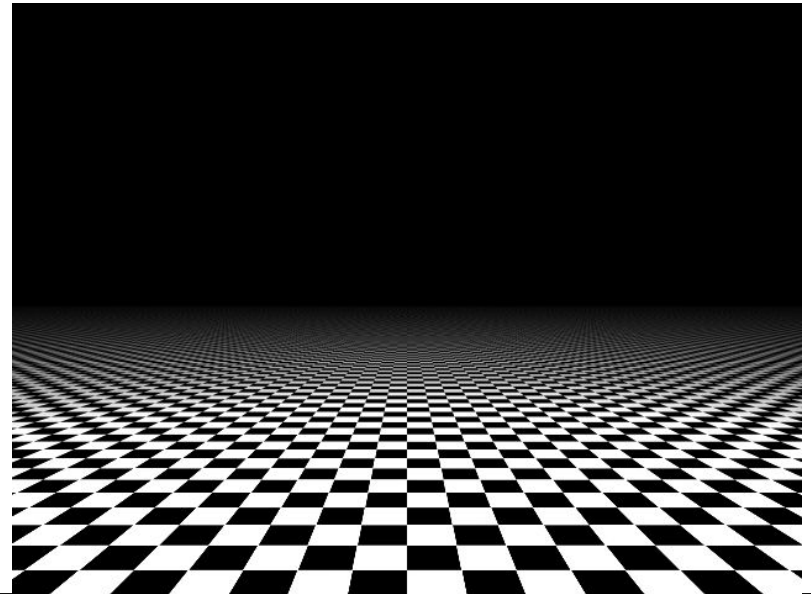
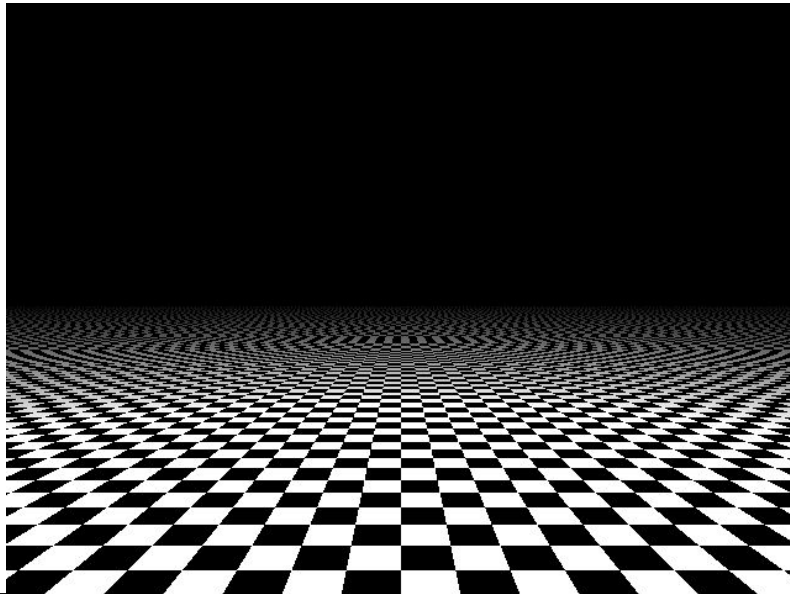

Pixel Pre-Image in Texture Space

- **Circular pixel footprints have elliptic pre-images on planar surfaces**
- **Square screen pixels form quadrilaterals**
 - On curved surface shape can be arbitrary (non-connected, etc...)
- **Possible approximation by quadrilateral or parallelogram**
 - Or taking multiple samples within a pixel

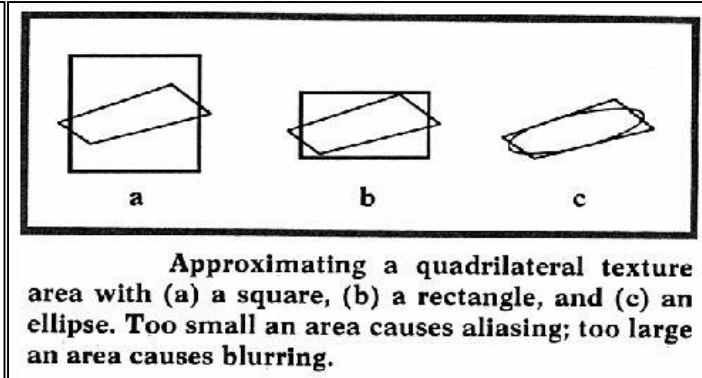
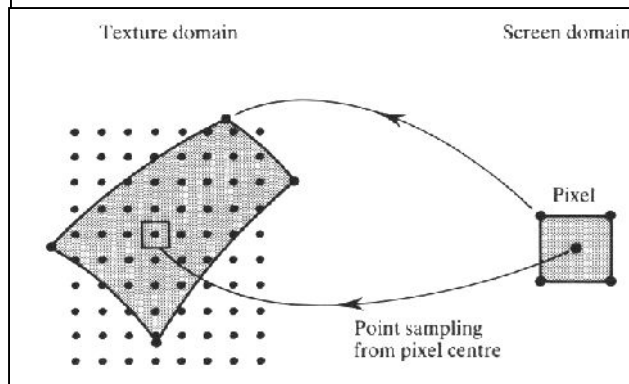
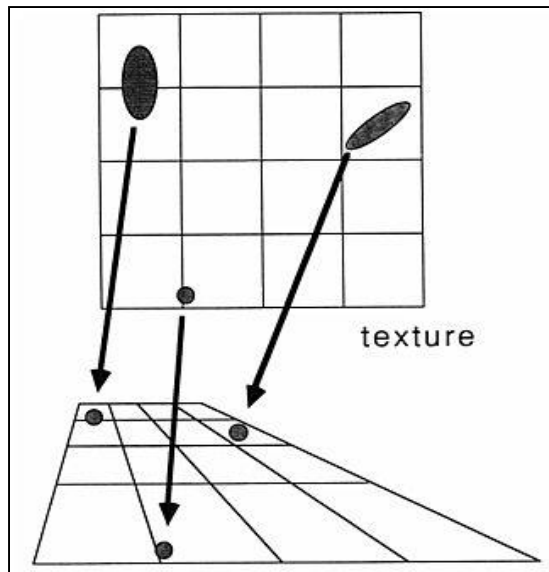

Space-Variant Filtering

- **Space-variant filtering**
 - Mapping from texture space (u,v) to screen space (x,y) not affine
 - Filtering changes with position
- **Space-variant filtering methods**
 - Direct convolution
 - Numerically compute the integral
 - Pre-filtering
 - Precompute the integral for certain regions \Rightarrow more efficient
 - Approximate actual footprint with precomputed regions

Direct Convolution

- **Convolution in texture space**

- Texels weighted according to distance from pixel center (e.g. pyramidal filter kernel)
- Essentially a low-pass filter

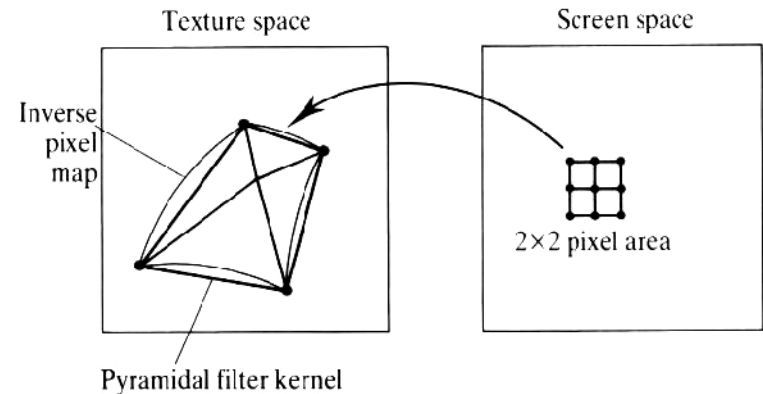

- **Convolution in image space**

- Center the filter function on the pixel (in image space) and find its bounding rectangle.
- Transform the rectangle to the texture space, where it is a quadrilateral whose sides are assumed to be straight.
- Find a bounding rectangle for this quadrilateral.
- Map all pixels inside the texture space rectangle to screen space.
- Form a weighted average of the mapped texels (e.g. using a two-dimensional lookup table indexed by each sample's location within the pixel).

EWA Filtering

- **EWA: Elliptical Weighted Average**
- **Compensate aliasing artifacts caused by perspective projection**
- **EWA Filter = low-pass filter \otimes warped reconstruction filter**

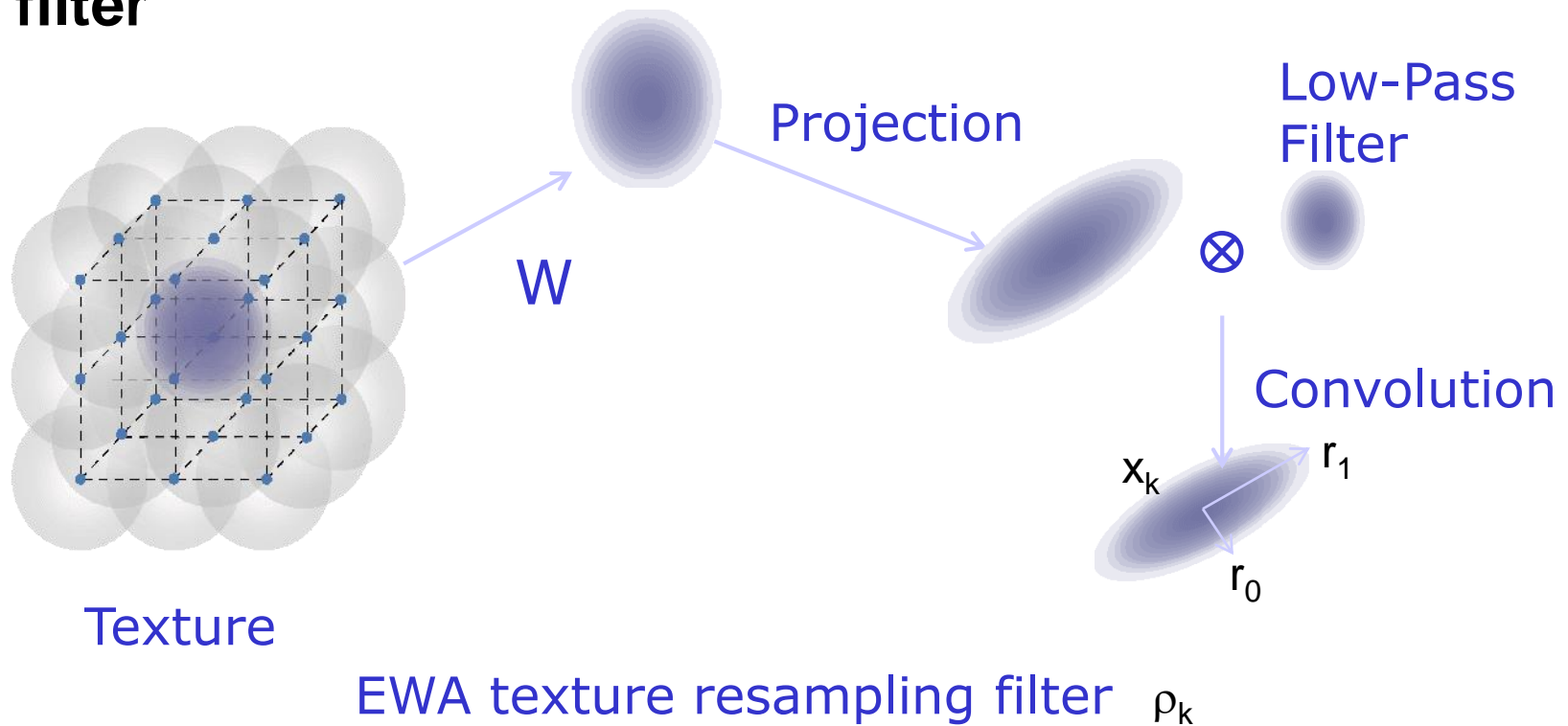

EWA Filtering

- **Four step algorithm:**
 1. Calculate the ellipse
 2. Choose low-pass filter
 3. Scan conversion in the ellipse
 4. Determine the color of the pixel

Without Anti-Aliasing

- Checker board gets distorted

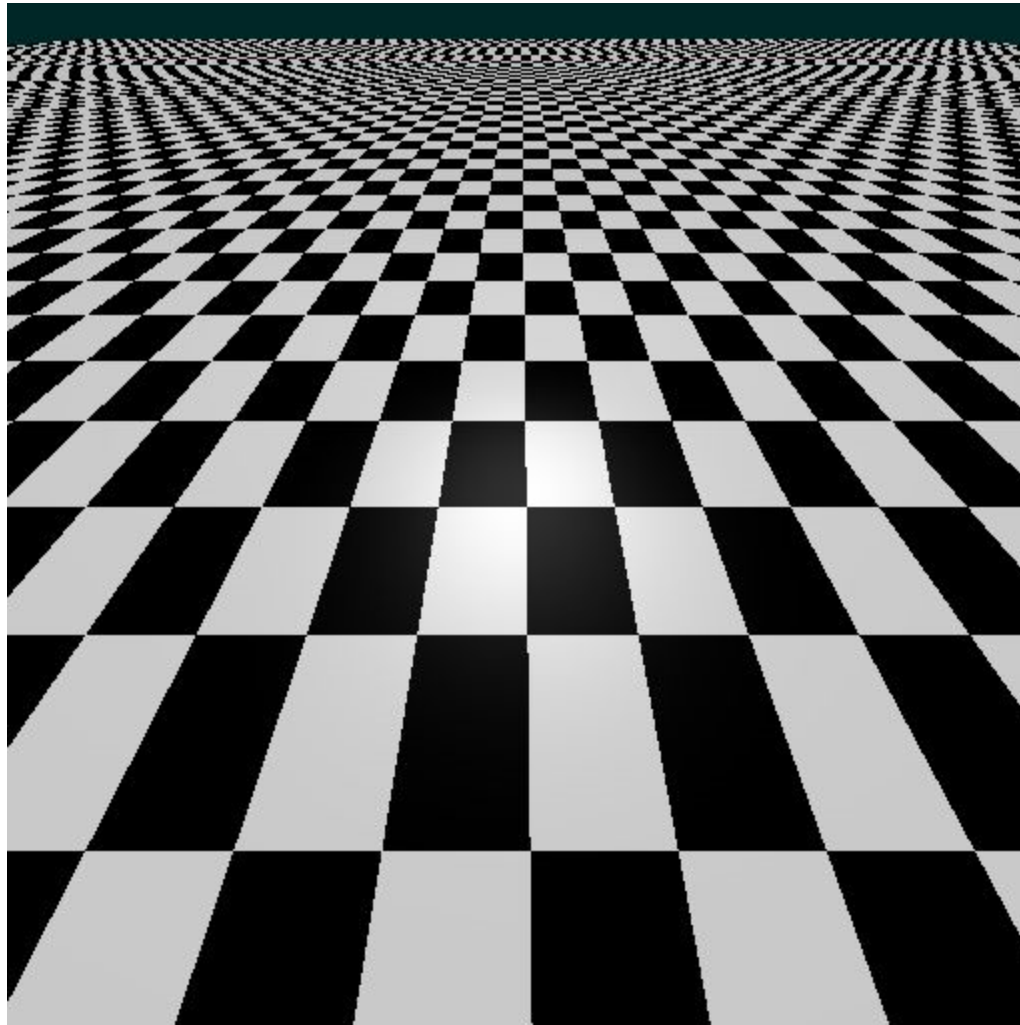

EWA Filtering

- **Elliptical filtering plus Gaussian**

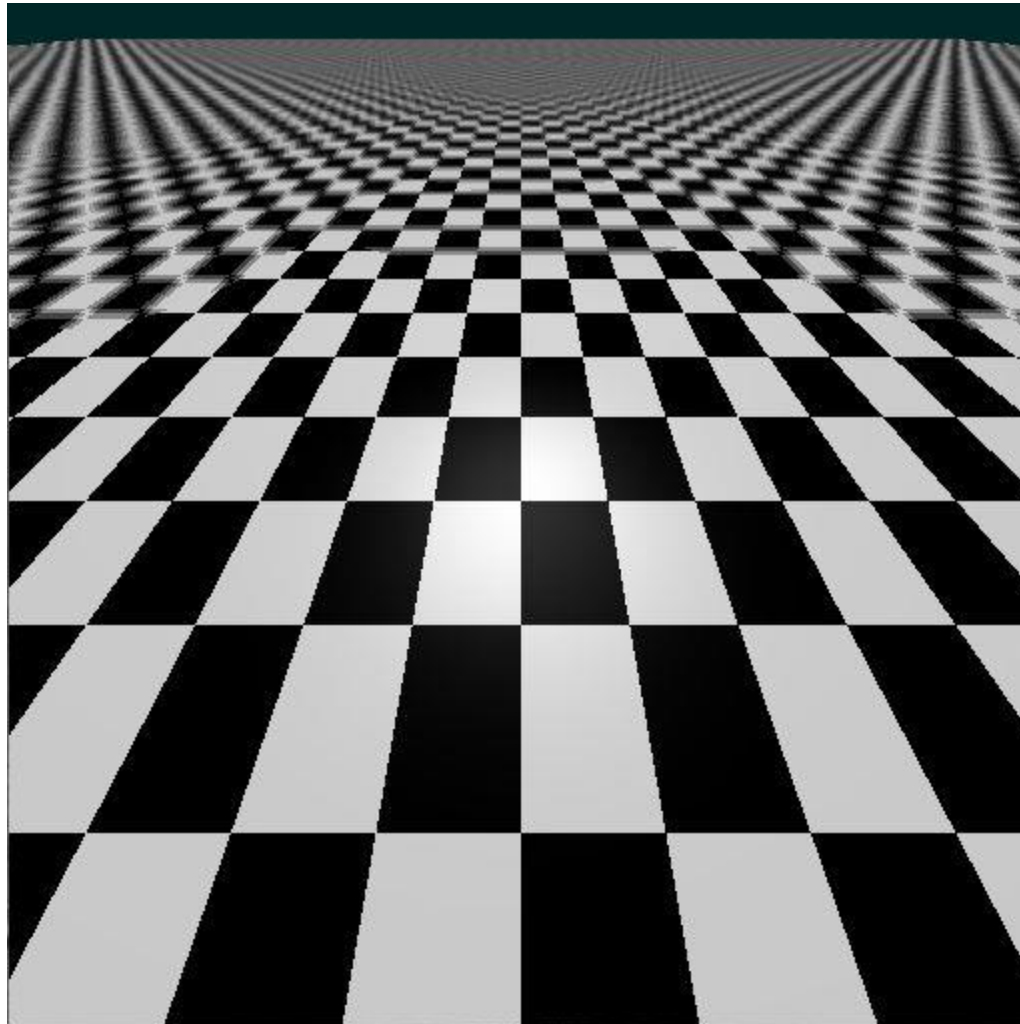

EWA Filtering

- Gaussian blur selected too large \Rightarrow blurry image

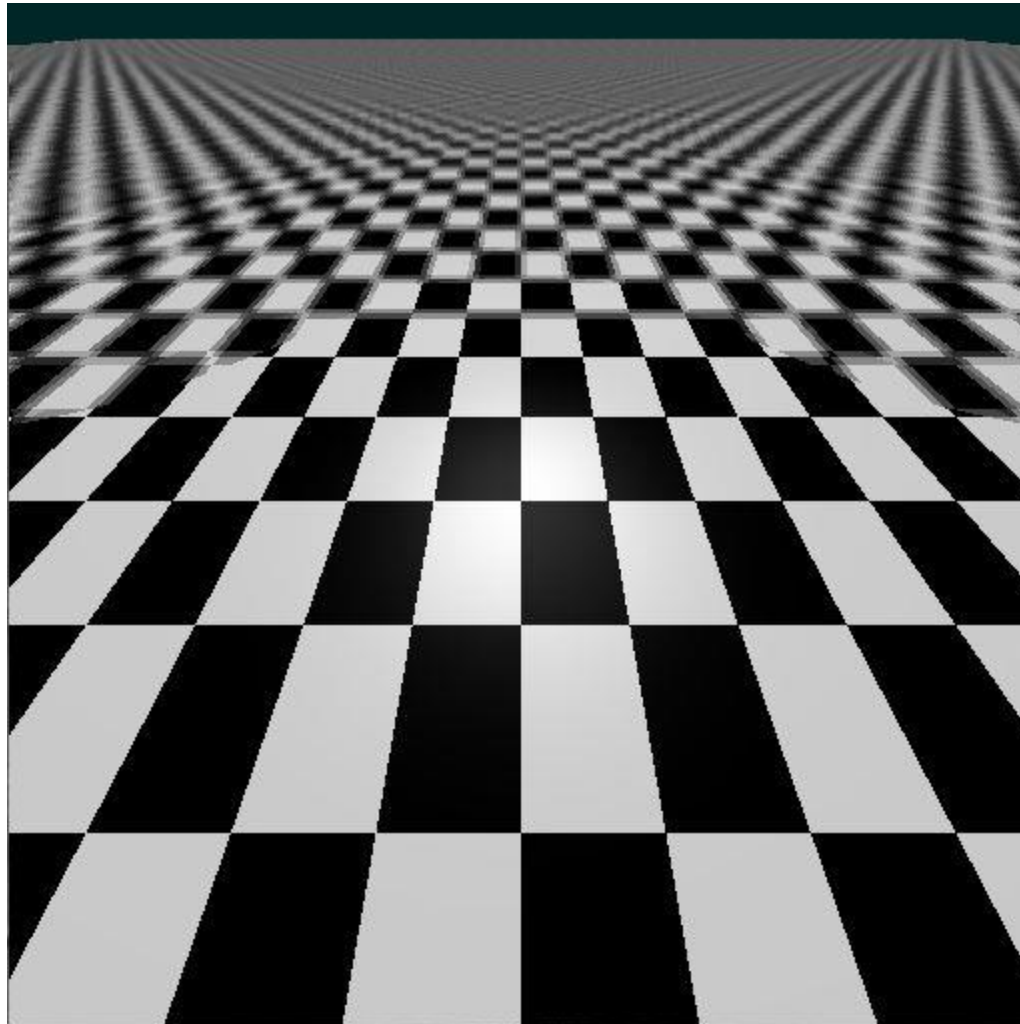

EWA Splatting

Zoom-out

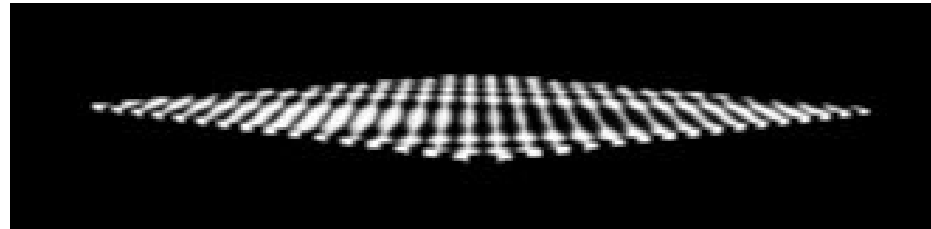

Reconstruction filter only

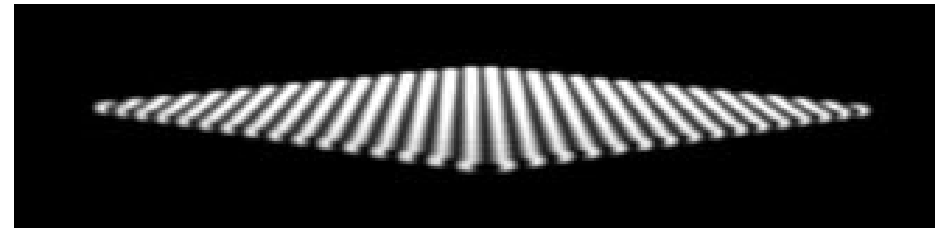

EWA filter

Zoom-in

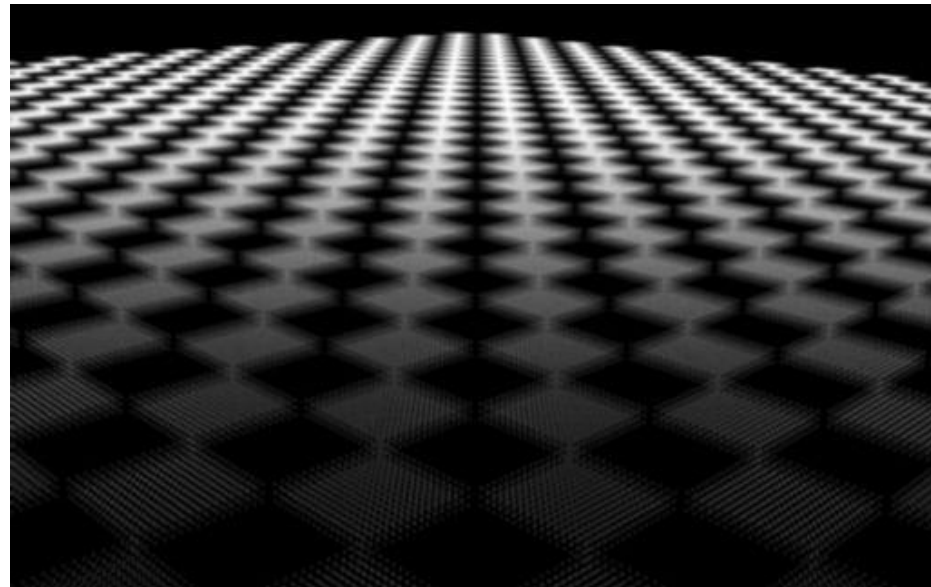

Low-pass filter only

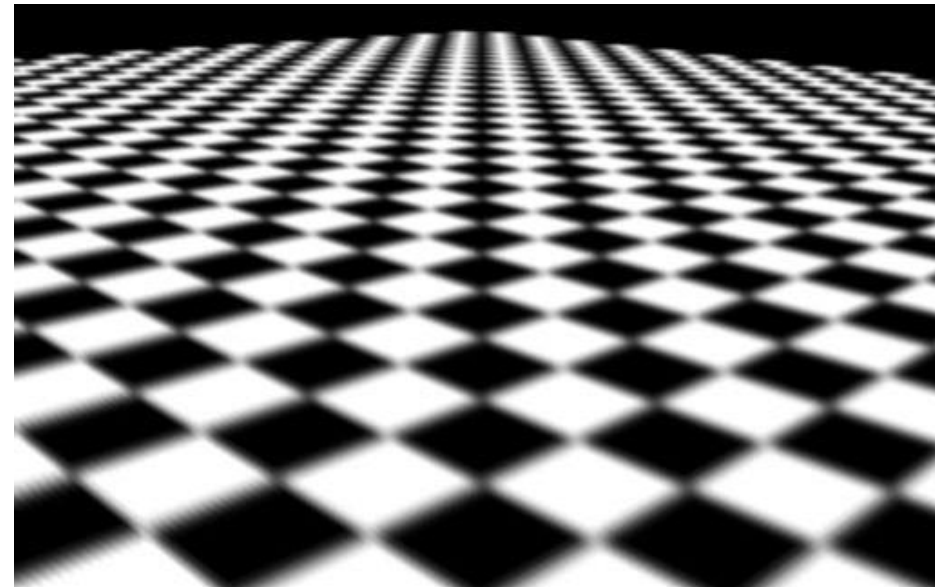

EWA filter

Pre-Filtering

- **Direct convolution methods are slow**
 - A pixel pre-image can be arbitrarily large
 - Along silhouettes
 - At the horizon of a textured plane
 - Can require averaging over thousands of texels
 - Texture filtering cost grows in proportion to projected texture area
- **Speed-up**
 - The texture can be prefiltered before rendering
 - Only a few samples are accessed for each screen sample
 - Two data structures are commonly used for prefiltering:
 - Integrated arrays (summed area tables - SAT)
 - Image pyramids (MIP-maps)
 - Space-variant filtering

Summed Area Tables (SAT)

- Per texel, store sum from $(0, 0)$ to (u, v)

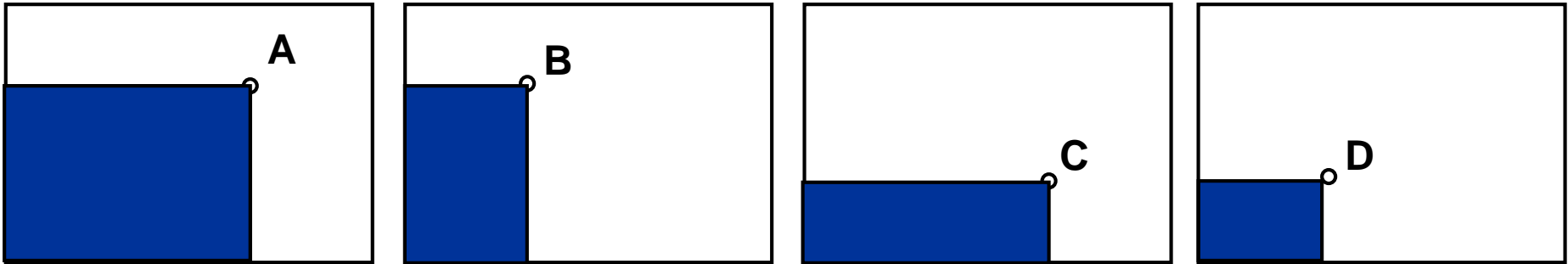

- Evaluation of 2D integrals in constant time!

$$\int_{Bx}^{Ax} \int_{Cy}^{Ay} I(x, y) dx dy = A - B - C + D$$

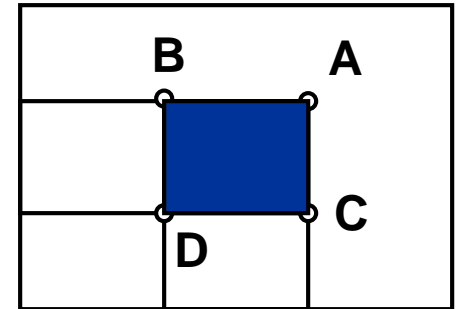

- Many bits per texel (sum over million of pixels!)

Integrated Arrays

- **Footprint assembly**

- Good for space variant filtering
 - E.g. inclined view of terrain
- Approximation of the pixel area by rectangular texel-regions
- The more footprints the better accuracy

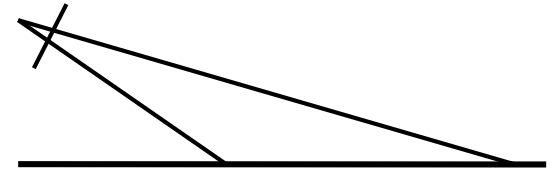

- **In practice**

- Often fixed number of area samples
- Done by sampling multiple locations within a pixel (e.g. 2x2), each with smaller footprint

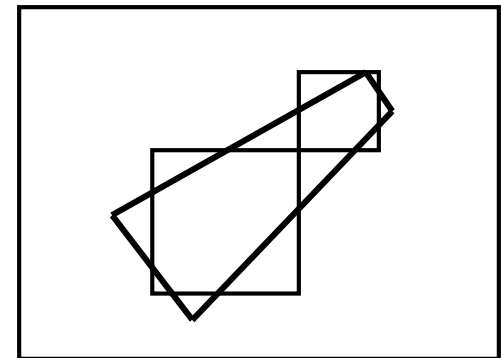

- **Anisotropic (Texture) Filtering (AF)**

- GPUs allow selection of #samples (e.g. 4x, 8x, etc.)

MIP-Mapping

- **Texture available in multiple resolutions**
 - Pre-processing step averaging surrounding texels
 - Discrete number of filter sizes (powers of 2)
- **Rendering**
 - Select appropriate texture resolution level n (per pixel !!!)
 - Texel size(n) < extent of pixel footprint < texel size($n+1$)

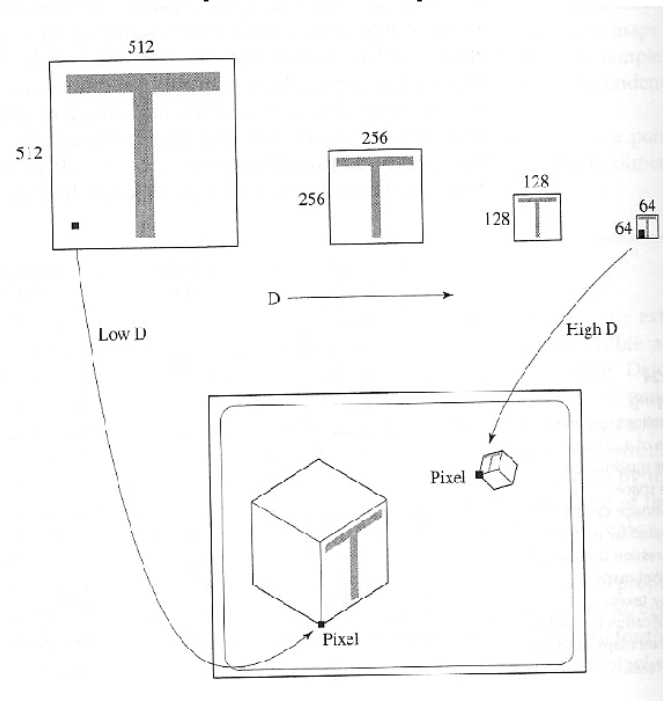

MIP-Mapping (2)

- **Multum In Parvo (MIP): much in little**
- **Hierarchical resolution pyramid**
 - Repeated averaging over 2x2 texels
- **Rectangular arrangement (RGB)**
- **Reconstruction**
 - Tri-linear interpolation of 8 nearest texels
 - Bilinear interpolation in levels n and $n+1$
 - Linear interpolation between the two levels

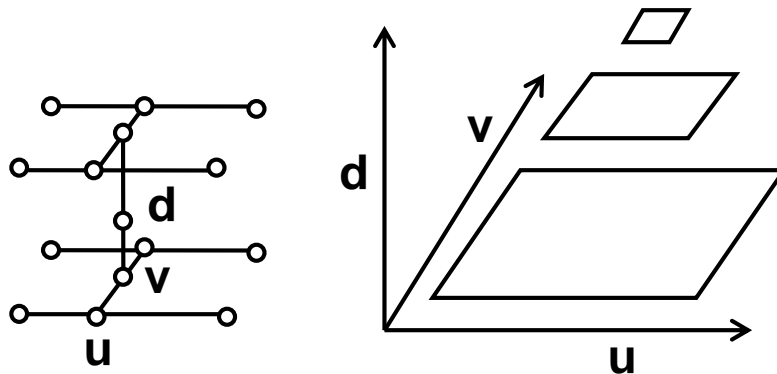
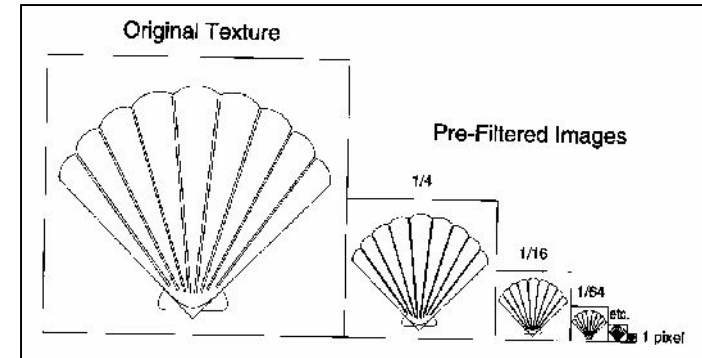

- “Brilinear”: Trilinear only near transitions
 - Avoid reading 8 texels, most of the time

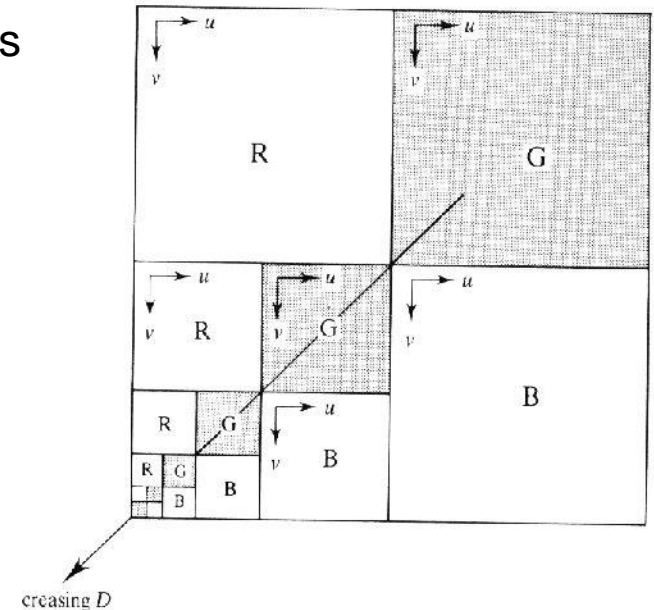

MIP-Map Example

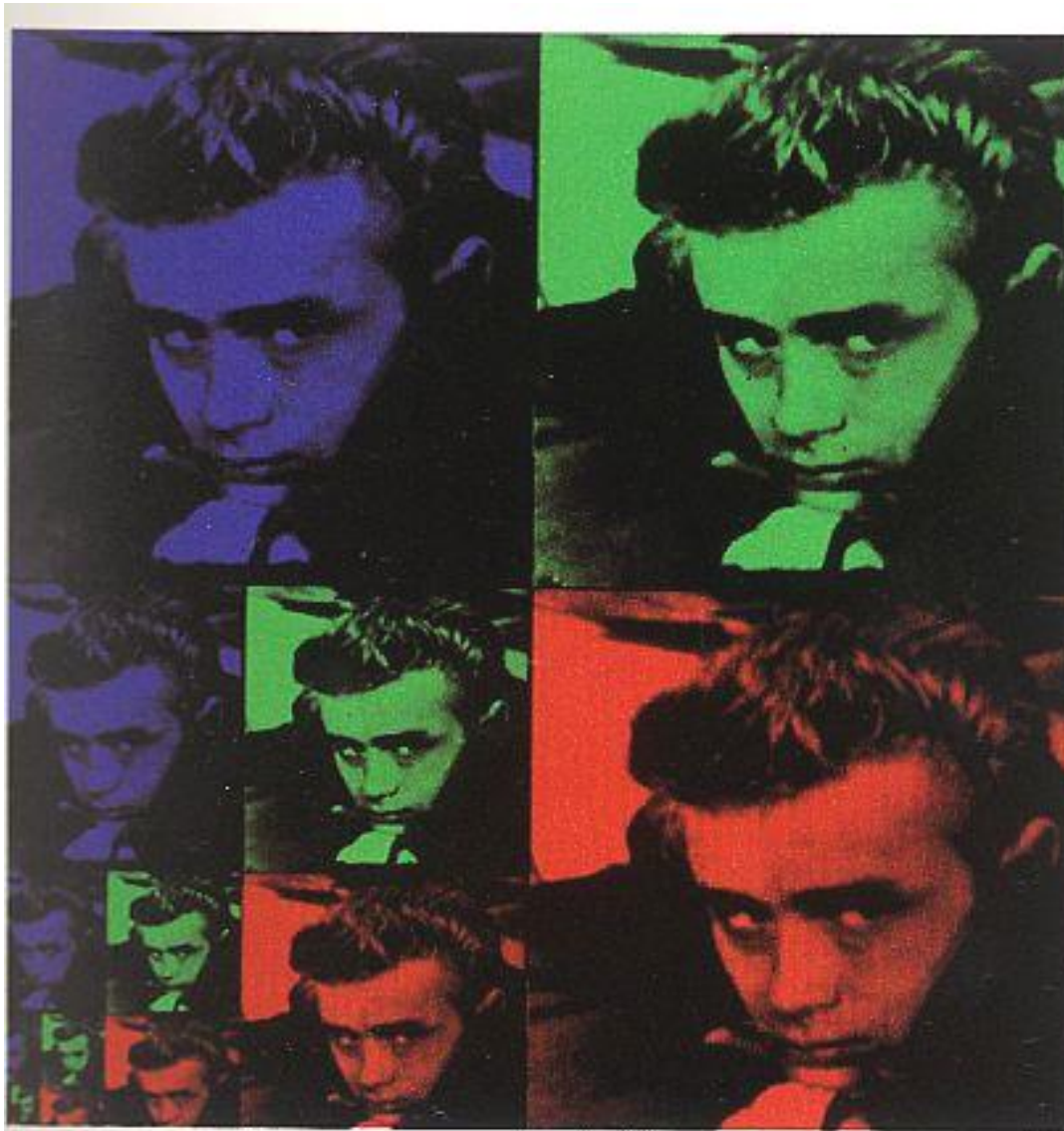

Hardware Texture Filtering

- **Bilinear filtering (in std. textured tunnel benchmark)**
 - Clearly visible transition between MIP-map levels

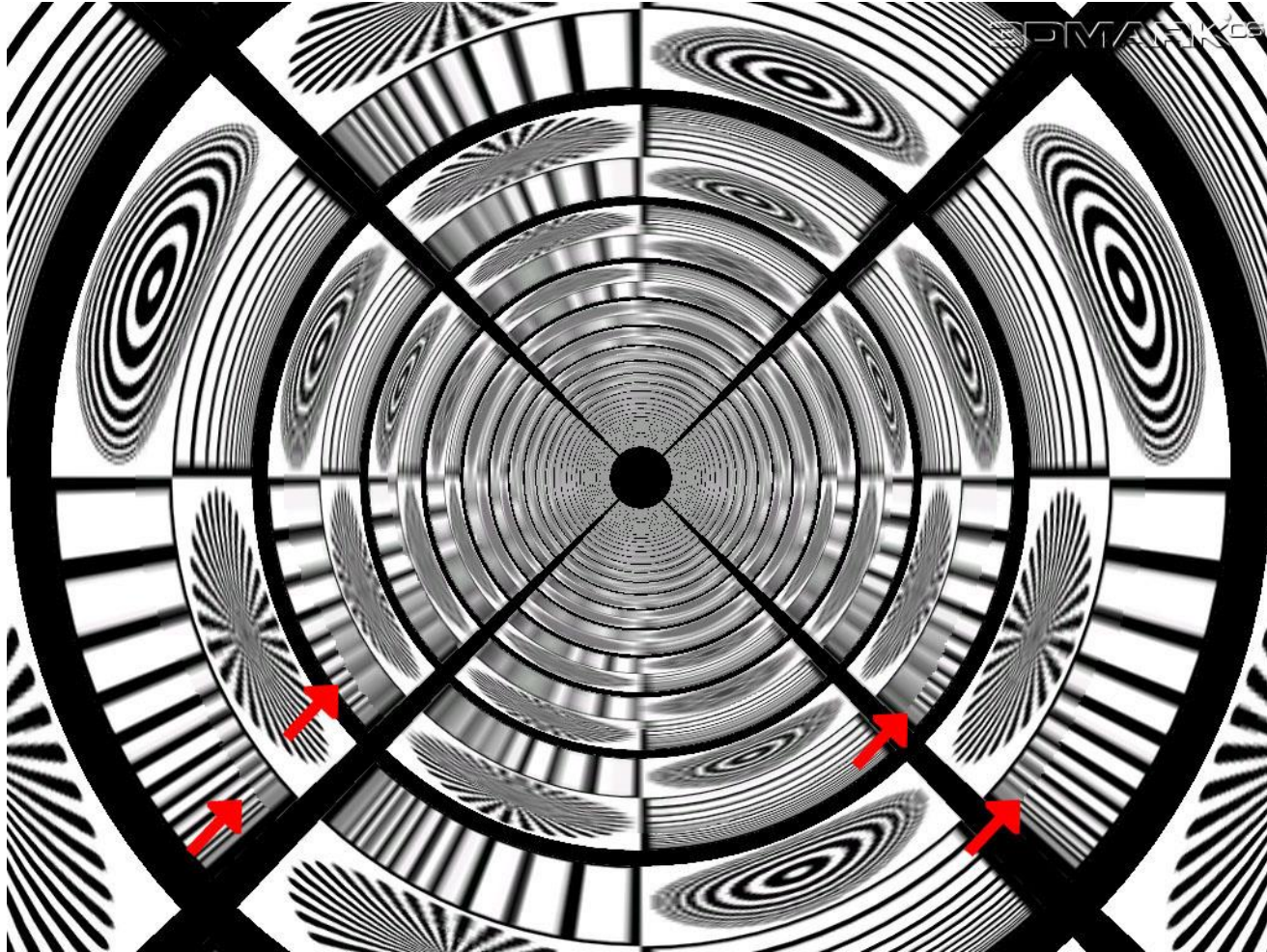

Hardware Texture Filtering

- **Trilinear filtering**
 - Hides the transitions between MIP-map levels

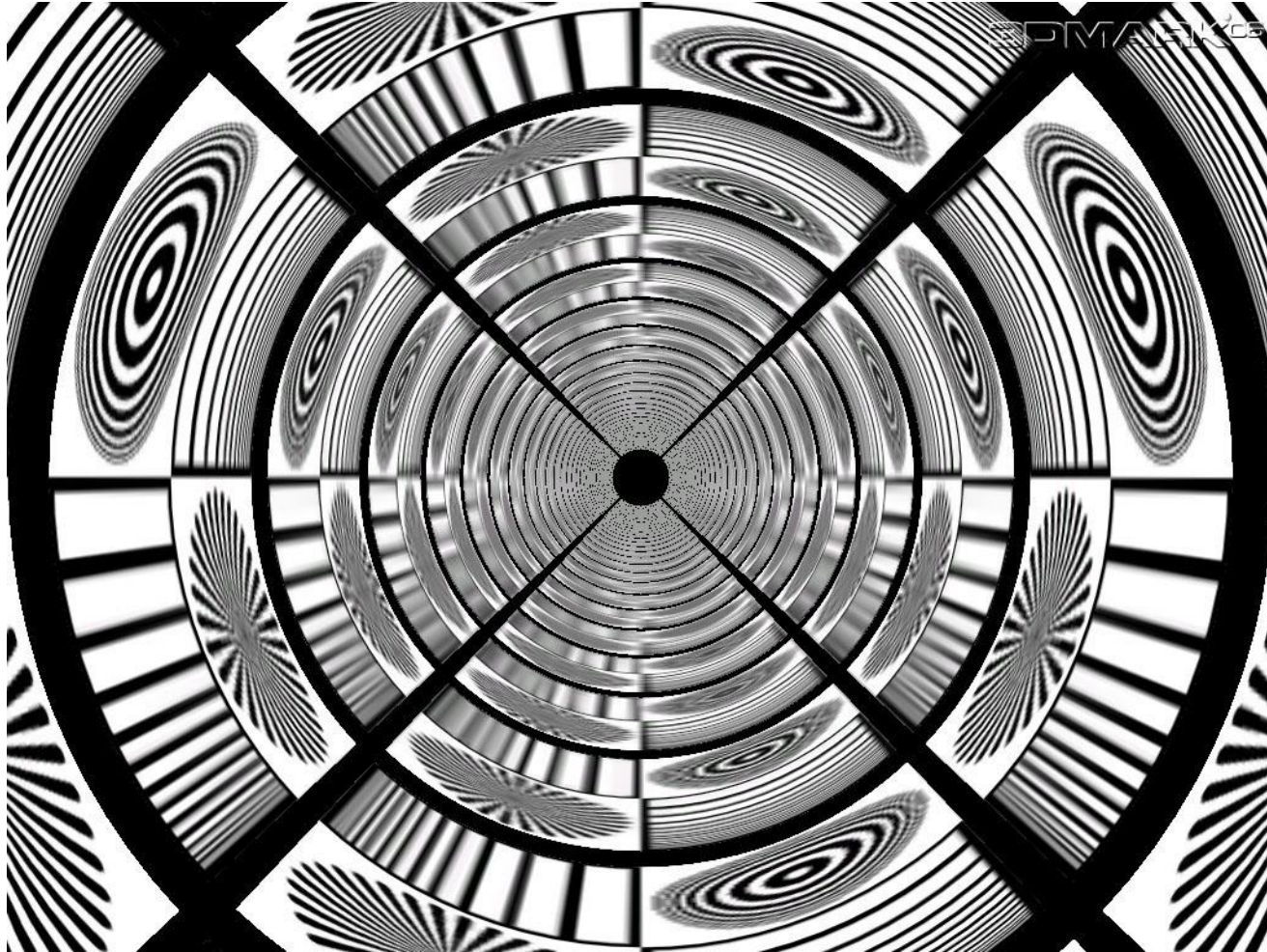

Hardware Texture Filtering

- **Anisotropic filtering (8x)**
 - Makes the textures much sharper along azimuthal coordinate

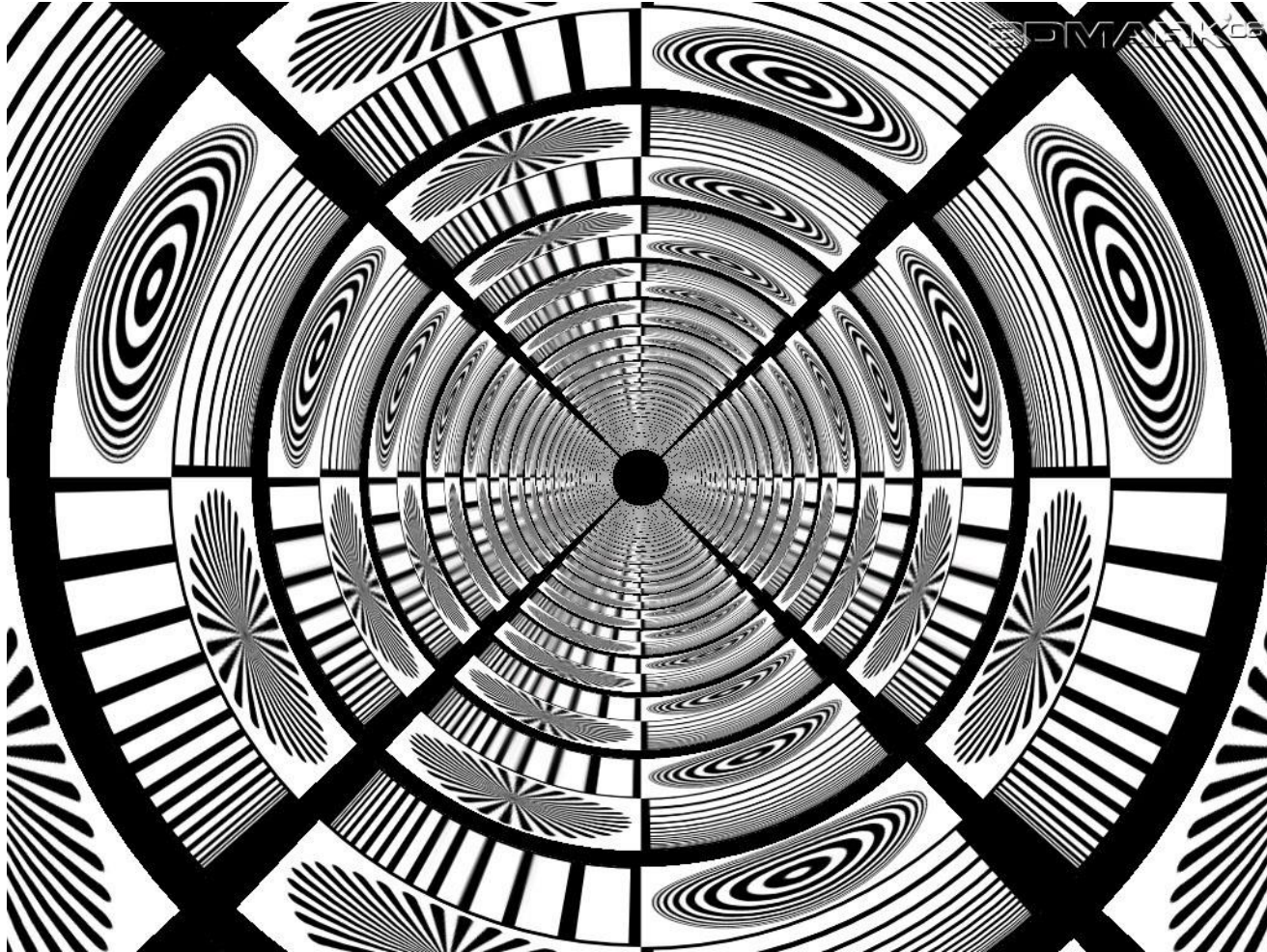

Hardware Texture Filtering

- **Bilinear vs. trilinear vs. anisotropic filtering**
 - Using colored MIP-map levels

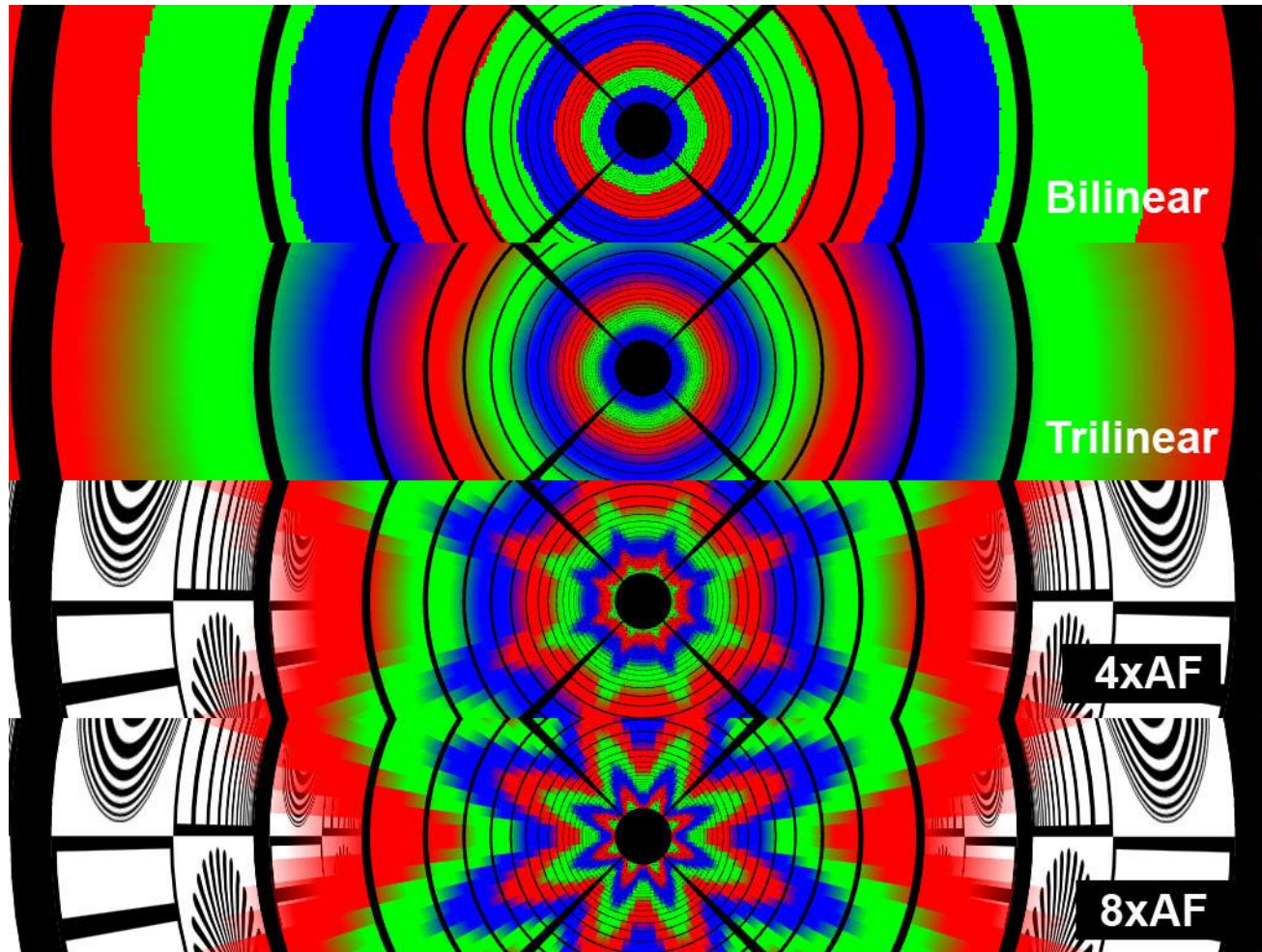

Texture Caching in Hardware

- **All GPUs have small texture caches**
 - Designed for local effects (streaming cache)
 - No effects between frames, or so!
- **Mipmapping ensures ~1:1 ratio**
 - From pixel to texels
 - Both horizontally & vertically
- **Pixels rendered in small 2D groups**
 - Basic block is 2x2 „quad“
 - Used to compute „derivatives“
 - Using divided differences (left/right, up/down)
 - Lots of local coherence
- **Bi-/tri-linear filtering needs adjacent texels (up to 8 for trilinear)**
 - Most often just 1-2 new texel per pixel not in (local) cache

